

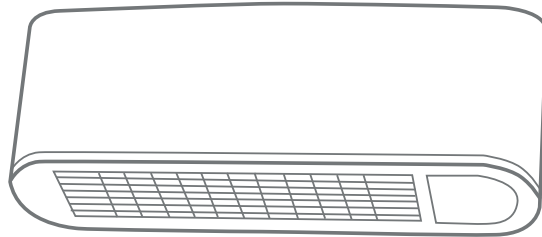

## INSTRUCTION MANUAL

2KW PTC High Level Heater (DXPTC2T)  
2KW PTC High Level Heater w/ Wi-Fi (DXPTC2W)



Tel: 01244 631370 | Email: [sales@dexprouk.com](mailto:sales@dexprouk.com)

## Introduction

Models covered by this instruction sheet:-

DXPTC2T/DXPTC2W 2000W PTC High Level Heater.



**IMPORTANT** Read these instructions fully before using the appliance.  
Retain these instructions for future reference.

**NOTE** The appliance may only be used in a fixed position and only for the purpose described. It is not for outdoor use!

## SAFETY INSTRUCTIONS

Please read these instructions before operating the appliance.

1. This product is a wall mounting appliance, never use it as portable appliance.
2. The heater must be installed at least 2 m above the floor.
3. This appliance is designed for wall mounting and must be used with the warm air vent facing downwards. This appliance should not be used in any other orientation and should not be used as a free standing portable appliance.
4. This appliance is suitable for installation on surfaces with normal flammability e.g. wood, plasterboard, masonry. It is not suitable for use on highly flammable surfaces (e.g. polystyrene, textiles).
5. Before making fixing hole(s), check that there are no obstruction hidden beneath the mounting surface such as pipes or cables.
6. The chosen location of your new appliance should allow for the product to be securely mounted (e.g. to a firm wall) and safely connected to mains supply.
7. Ensure the power supply to the socket into which the appliance is plugged is in accordance with the rating label on the appliance and that the socket is earthed.
8. Keep the mains lead away from the hot body of the appliance.
9. Do not use outdoors.
10. Do not cover or obstruct any of the heat outlet grilles or the air intake openings of the appliance.
11. Do not place the appliance on carpet.

12. Always ensure that the appliance is placed on a firm level surface. Ensure that the appliance is not positioned close to flammable materials as this could create a fire hazard.
13. Do not position the appliance in front of, or immediately below, a wall socket.
14. Do not insert any object through the heat outlet or air intake grilles of the appliance.
15. Do not use the appliance in areas where flammable liquids are stored or where flammable fumes may be present.
16. Always disconnect the appliance when moving it from one location to another.
17. Do not use the appliance if the power cord is damaged. If the power cord is damaged it must be replaced by a recognised service agent or other qualified person.
18. Only use a suitable 13amp supply.
19. This appliance is not intended for use by persons (including children) with reduced physical, sensory or mental capabilities, or lack of experience and knowledge, unless they have been given supervision or instruction concerning use of the appliance by a person responsible for their safety. Children should be supervised to ensure that they do not play with the appliance.

## SPECIFICATIONS

Model	Voltage	Power	Dimensions
DXPTC2T /W	220-240V-50Hz	2000W	500 x 200 x 120mm

## Installation

1. Choose the location for your new appliance giving consideration to all of the points above.
2. Using the guide diagram below, mark the position of the two fixing holes. The unit needs to be installed a minimum of 2 metres above the floor.
3. Use a spirit level to check hole are level.
4. Drill the top two fixing holes.

5. Insert the plastic rawl plugs and screws leaving approximately 10mm of the screw protruding.
6. Hang the appliance on the screws. If the fixings supplied are not suitable for your mounting surface, select suitable alternatives.

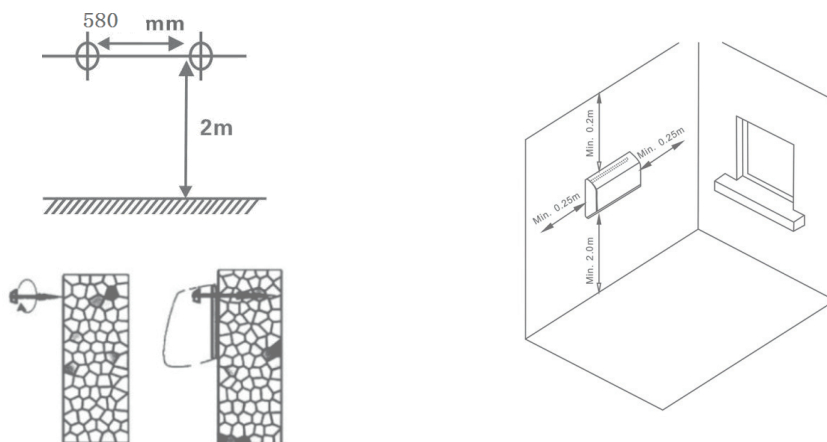

## Operation

Before inserting the plug into an electrical outlet, make sure that the electrical supply in your area matches that on the rating label on the unit.

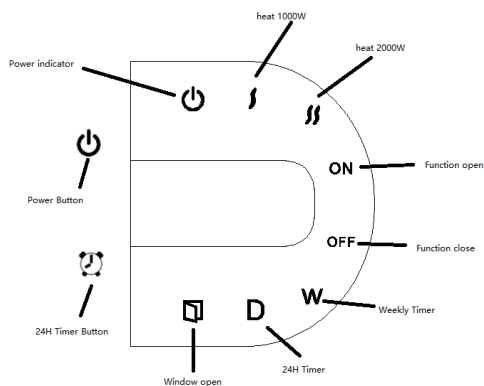

- ⏻ Main power button
- "24H" Setting timer from 1-24 hours
- "MODE" COLD, WARM, HOT 3 setting for selection
- "LOCK" Child-Lock function for heater
- "AUTO" Window Open Function
- "Tem." Display real time
- "Delay" Set temperature for weekly function
- "W.Timer" Set the timer of one week
- "+" Increase
- "-" Decrease
- "Set" Set real time

## General Use

1. Turn the heater ON by pressing the "⏻" button on the remote control or control panel, the unit will blow the cold air and "⏻" light is on with blue color.
2. Pressing the "MODE" button on remote control, the unit will blow the warm air and the "⏻" light is on. Pressing the "MODE" button second times on remote control, the unit will blow the hot air and both "⏻" light is on.
3. For cold air press the "MODE" button three times on remote control

## 24 Hour Timer Function

1. With the unit switched on, press "24H" button or "⌚" button. To set the timer up to 24 hours, keep pressing "24H" button or "⌚" button to increase the hours from 00:00--24:00 (01:00=1 hour,...24:=24:00 hours ect.) and the "D" light is on.  
Note: Set as "00" means no set timer and the "D" light is off.

## Thermostat Instructions

1. Adjusting the temperature is done by using the remote control. With the unit switched on press the "+ -" to set the desired temperature and the temperature set from 10°C to 49°C.
3. When the air temperature drops 2 degree below the set temperature, the heater will start heating and "⏻" will illuminate (2000W).
4. When the air temperature high 1 degree or ≥ the set temperature, the heater will blow the cold air.

## Weekly Timer Function

Adjusting the timer is done by using the remote control. First, set the time;

**Set Week Day** Press "Set" button, "1" will flash on the LED display, press "+ -" buttons to set the day from 1-7 (1=Monday, 7=Sunday)

**Set Hour** Press "Set" button again, "00" will flash on the LED display, press "+ -" buttons to set the Hours from 01-00(01=1 o'clock, 02=2 o'clock, 00=24 o'clock)

**Set Minute** Press "Set" button again, "00" will flash on the LED display, press "+ -" buttons to set the Hours from 00-59(01=1 Minute, 02=2 Minute)

Note: After pressing the "Set" button, the LED display will flash for 5 seconds for you to make adjustment, if no button is pressed, the unit will return back to standby. (Appliance will keep the right time until power off)

## Set Weekly Timer

**Set Monday** Press "W.TIMER" button, "1" will be shown on the LED display

**Start Hour** Press "W.TIMER" button again, "00" will flash on the LED display, press "+ -" buttons to set the Hours from 01-00(01=1 o'clock, 02=2 o'clock, 00=24 o'clock)

**Start Minute** Press "W.TIMER" button again, "00" will flash on the LED display, press "+ -" buttons to set the Hours from 00-59(01=1 Minute, 02=2 Minute)

With the "ON" light on, it means open time.

## Set Weekly Timer (Cont)

**Finish Hour** Press "W-TIMER" button again, "00" will flash on the LED display, press "+ -" buttons to set the Hours from 01-00(01=1 o'clock, 02=2 o'clock, 00=24 o'clock)

**Finish Minute** Press "W-TIMER" button again, "00" will flash on the LED display, press "+ -" buttons to set the Hours from 00-59(01=1 Minute, 02=2 Minute)

With the "OFF" light on, it means close time.

**The above are finished set Monday Timer.**

Press "W-TIMER" button again, "2" will be shown on the LED display meaning "Tuesday". complete the above steps for start & finish time. Continue setting the time for each day of the week.

**Set Temperature** When the time is set for each day, press "DELAY" button on remote control to set the temperature. Press "+ -" buttons to select the required temperature. The temperature range from 10°C to 49°C.

You can set different start & finish time and temperature for the whole week.

## Open Window Detection

1. To turn on open window detection with the remote control, press "AUTO" button, the "W" light is on. The appliance is working in smart saving energy mode. (In this function, the appliance is check and record environment temperature in immediate area. It will stop working when the temperature drops by 3°C within 1 minute. The user should restart the appliance with "ON" button). Press "AUTO" button again to turn the function off.

## Child-Lock Function

Adjusting the timer is done by using the remote control

1. In any mode, press the "LOCK" button once, only the "Power" light will display. The control panel and remote control will not operate the appliance.
2. Press the "LOCK" button, all lights will illuminate and both control panel and remote control can functional again.

## Wi-Fi Function (DXPTC2W)

Connection by WIFI

1. Use your phone to scan the QR code below or search and download "Tuya Smart". Install the App.
2. Select your country code, enter the phone number and tap "Get" to receive a message containing verification on code.
3. Switch on the product and make sure the product is in Wi-Fi covered environment.
4. The indicator light will rapidly blink.
5. Go to the App, tap "add device", as shown in the picture 1,
6. Select "Small Home Appliance" then select "Heater" symbol (Pic. 3)
7. Press the "confirm indicator rapidly blinks" when the indicating light on device rapidly blinks,as shown in Pic. 4.
8. Input password of WIFI and then confirm,as shown in Pic. 5.
9. Wait for the APP to connect with the device until it is connected successfully as shown in Pic. 6.

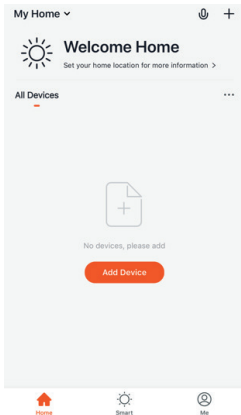

Pic. 1

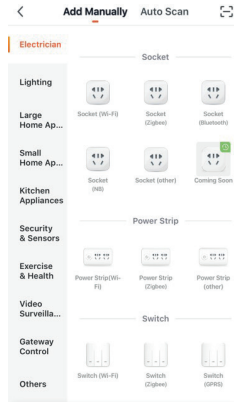

Pic. 2

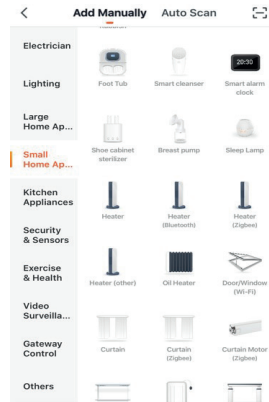

Pic. 3

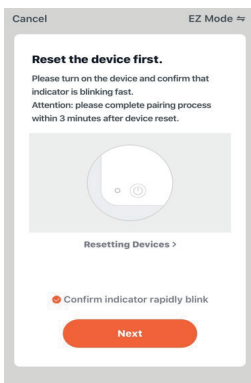

Pic. 4

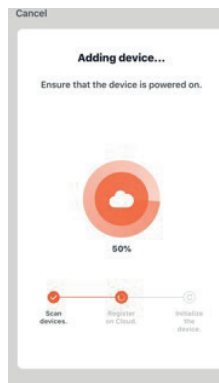

Pic. 5

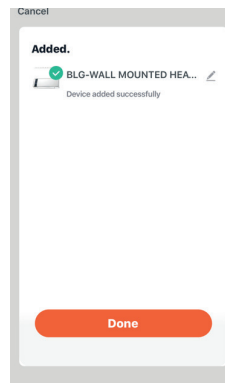

Pic. 6

## Operation by Wi-Fi

1. You can operate the device by mobile under WIFI or 4G LTE environment, as shown in Pic. 7.
2. Press Switch to turn the unit on & off (Pic. 7)
3. Press Level to display/select heating level options (Pic. 8)
4. Press Countdown Timer to display/select timer (Pic. 9)
5. Pressing Settings will display setting options (Pic. 10)



Pic. 7

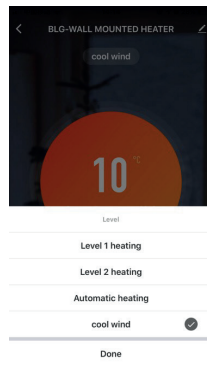

Pic. 8

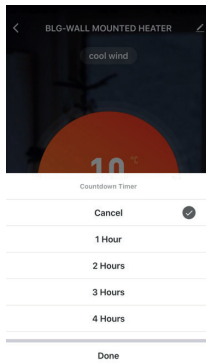

Pic. 9

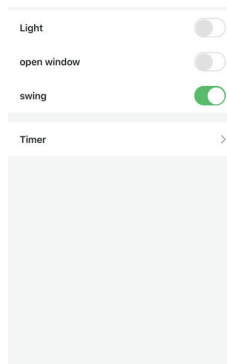

Pic. 10



## Setting Timer Schedule

1. In settings, select "Timer"

A) Press "Add schedule" (Pic.11).

B) Set time to turn unit on, and use the repeat function to select frequency.

C) Press the "Save" button in top right corner (Pic.12). Repeat step B & C as required.

D) Press the "<" button in top left corner to see current saved schedule.

E) To delete an entry, slide it to the left and click Delete (Pic. 13).

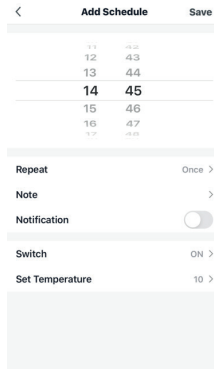

Pic. 11

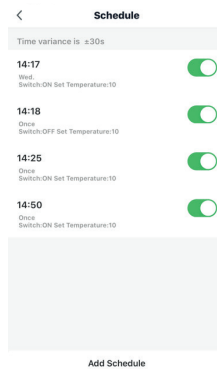

Pic. 12

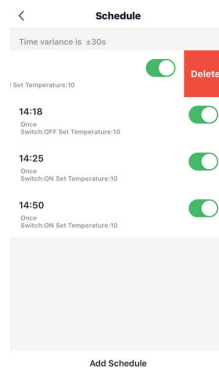

Pic. 13

## Overheat Protection

This heater is protected with overheat protection that switches off the appliance automatically in case of overheating. For example: due to the total or partial obstruction of the vents. In this case, unplug the appliance, wait about 30 seconds for it to cool and remove any object which may be obstructing the vents. Then switch it back on as described above. The appliance should now operate normally.

## Cleaning The Appliance

1. Always isolate the appliance from the power supply and allow it to cool down before cleaning.
2. Clean the outside of the appliance by wiping with a damp cloth and buff with a dry cloth. Do not use any detergents or abrasives and do not allow any water to enter the appliance.

## Storing The Appliance

When the appliance is not used for long periods of time it should be protected from dust and stored in a clean dry place.

## Warranty

1. This product is guaranteed for a period of 12 months from the date of purchase against faulty components and manufacturing defects.
2. This warranty does not cover wear and tear, or misuse and abuse. Transportation, freight cost and labour costs are excluded.
3. Before taking any action in the event of a fault, contact our customer service team who will assist you. The products serial number and proof of purchase must be provided.

In the event of a faulty product, deXpro will replace faulty parts or at its sole discretion replace the product.

INFORMATION FOR CORRECT DISPOSAL OF THE PRODUCT IN  
ACCORDANCE WITH THE EUROPEAN DIRECTIVE 2002/96/E.



At the end of its working life this equipment must not be disposed of as household waste. It must be taken to a local authority waste collection centre or to a dealer providing this service. Disposing of electrical and electronic equipment separately enables its components to be recovered and recycled to obtain significant savings in energy and resources. In order to underline the duty to dispose of this equipment separately, the product is marked with a crossed out dustbin.

Tel: 01244 631370 | Email: [sales@dexprouk.com](mailto:sales@dexprouk.com)